

HFS Ex H



The HFS Ex Hazardous Area Horizontal Float Switch is a float operated magnet arm on a reed switch sensor stem for control and indication of a liquid level while in a potentially explosive atmosphere.



Features include:

- ATEX and IECEx Ex d approved.
- Voltage free SPST or SPDT reed switch contacts.
- Stainless steel 316L housing and wetted components.
- Custom mounting options available.
- Suitable for high liquid temperatures.
- Suitable for gas and dust environments.
- IP68 Ingress protection.
- Suitable for low specific gravity liquids.
- M20 or 1/2" NPT cable entry.

ATEX Coding:



II 1/2G 2D

Ex db IIC (*) Ga/Gb

Ex tb IIIC (*) Db

-20°C ≤ Tamb ≤ +85°C

* Temperature class options to suit the environment and process temperatures.

T5 / T100oC for process temperatures ≤ 85°C

T4 / T135oC for process temperatures ≤ 125°C

T3 / T200oC for process temperatures ≤ 190°C

ATEX Certificate: ExVer 17ATEX0280X

IECEx Certificate: IECEx ExV 17.0016X



Poppenbouwing 54, 4191 NZ Geldermalsen,
T: 0345 596 000, info@adinco.nl, www.adinco.nl



Deeter Electronics Ltd.
Deeter House, Valley Road
Hughenden Valley
Bucks, HP14 4LW

Tel: +44 (0) 1494 566 046
Fax: +44 (0) 1494 563 961
Email: sales@deeter.co.uk
www.deeterelectronics.com

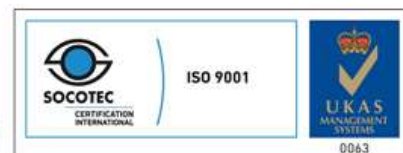

HFS Ex H



Type	Specification	
Sensor technology	Reed switch operated by float on magnetic arm	
Sensor tube and wetted materials	Stainless steel 316L	
Connection head material	Stainless steel 316L	
IP rating with suitable cable gland	IP68	
Approximate weight	1.2Kg to 2.5Kg depending on mounting option selected	
Float Diameter: Specific gravity	53mm : 0.65	Other floats available
Maximum liquid temperature: For T5/100°C hazard environment For T4/135°C hazard environment For T3/200°C hazard environment	-20 to +85°C -20 to +125°C -20 to +190°C	
Maximum head temperature	-20 to +80°C	Note 1
Maximum operating pressure	150PSI / 10Bar standard 450PSI / 31Bar	Note 2
Thread connection-Sensor tube	1/2"-14 NPT	
Thread connection-Wiring port	1/2"-14 NPT or M20X1.5	
Voltage free contact switch rating: SPST Form A SPDT Form C	0 to 240Vac. 1Amp. 50Watts Max 0 to 50Vdc. 0.25Amp. 20Watts Max	

Note 1: When this equipment is intended to be used in a liquid with a process temperature above 85°C it is an essential requirement that the sensor head temperature is measured to determine if the ambient air cooling is sufficient to keep the head below 80°C. See installation manual for detail.

Note 2: The HFS Ex sensor float and tube can withstand the stated pressure when sealed inside a tank. The connection head and resin seal to the sensor stem must not be pressurised. The pressure of the hazardous zone must not exceed normal atmospheric conditions (0.8 to 1.1bar).

The standard Zone 0 fittings are rated at 10bar, these fittings are not part of the certified flameproof seal and should not be considered as part of an explosion proof containment. Please call our technical sales department regarding sensors for liquid pressures up to 31bar.



Poppenbouwing 54, 4191 NZ Geldermalsen,
T:0345 596 000, info@adinco.nl, www.adinco.nl



Deeter Electronics Ltd.
Deeter House, Valley Road
Hughenden Valley
Bucks, HP14 4LW

Tel: +44 (0) 1494 566 046
Fax: +44 (0) 1494 563 961
Email: sales@deeter.co.uk
www.deeterelectronics.com

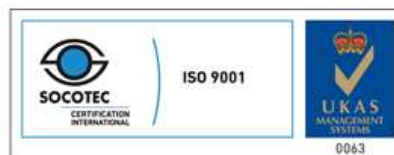

HFS Ex H

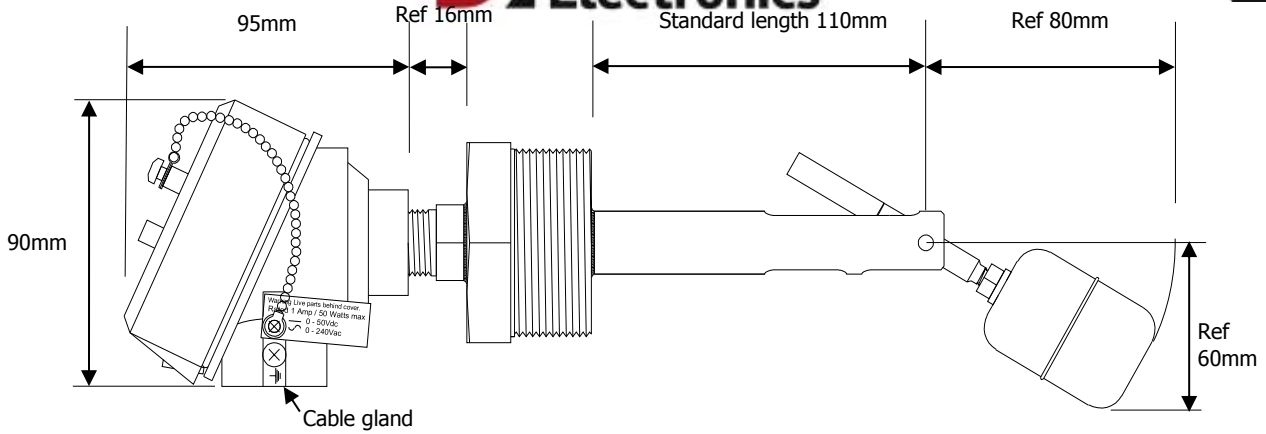
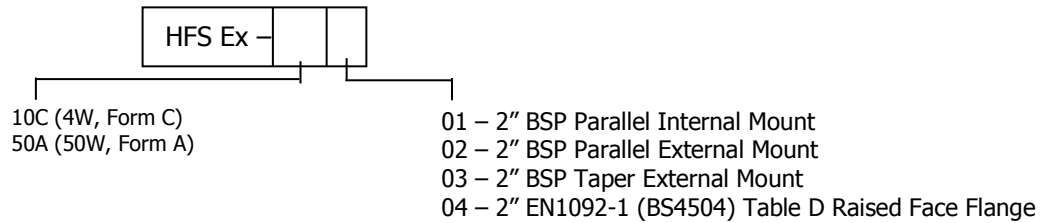

Diagram 1

Ordering Code



Example: HFS Ex-10C01 = Hazardous Area Horizontal Float Switch Level Switch, 4 Watt Form C switch, 2" BSP Parallel Internal Mount.

Custom sensor lengths and mounting options are available. Please contact our sales office for more information.

All electrical equipment should be installed by a qualified/certified electrician.

Deeter Electronics follows a policy of continual development of its products and reserves the right to change specifications and / or features without notice.

Identification

The HFS Ex sensors covered by this document can be identified by these labels attached to the sensor head.

Both the head label and the sensor tube end stop are marked with their date of manufacture in the form of 2 letters.

The S/N: xxxxxx is a unique serial No. given to each piece of equipment.

The HFS Ex: xxxxxx is a 6 digit model code.

The model code is also the Deeter reference number of a drawing which identifies the electrical connections and custom mechanical dimensions. A copy of this drawing should be attached to this manual.

The temperature class shown here as a * will be either T5/100°C, T4/135°C or T3/200°C

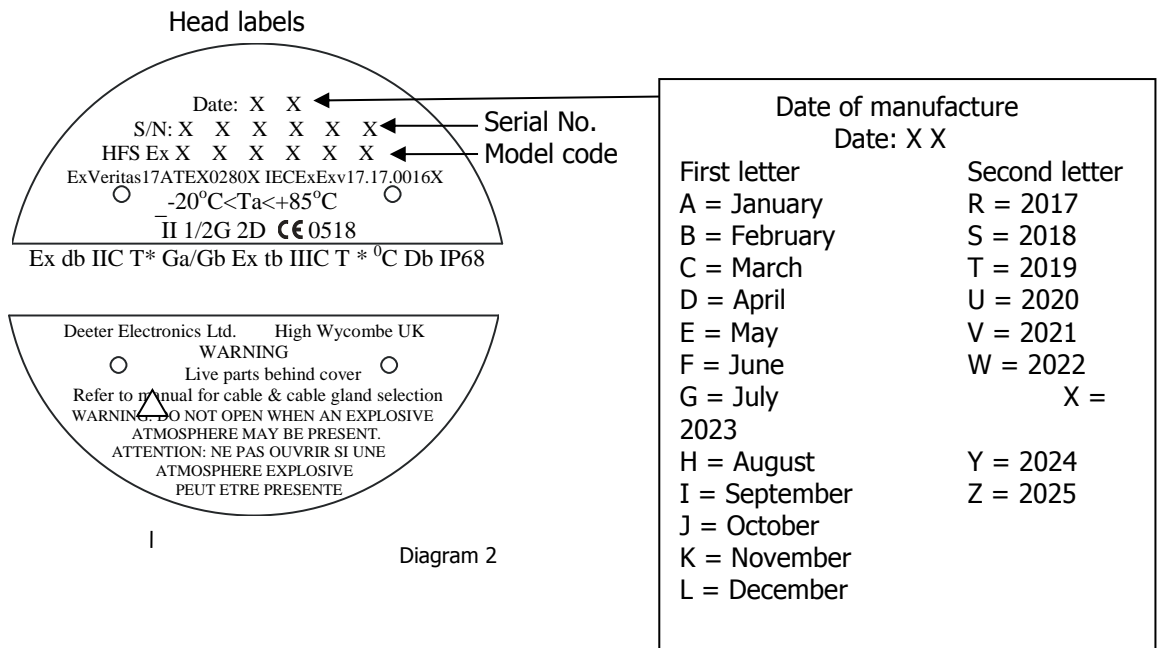

Instruction for mounting and wiring a HFS Ex

1) This document details the installation of all versions of standard Deeter HFS Ex and their mounting option / zone seal.



2) Do not open the lid or disconnect any part of the sensor when an explosive atmosphere may be present. Mounting and wiring must only be carried out in a safe environment. This device must be installed in accordance with IEC/EN60079-14.

3) When required a HFS Ex can be installed across a hazard location Zone boundary. It is essential that equipment mounted across a Zone 0 and Zone 1 boundary are installed with a sufficiently tight joint in accordance with clause 4.6 of EN60079-26 to provide an IP67 seal between zones.

4) To ensure reliable operation the HFS Ex must be mounted horizontally $\pm 5^\circ$.

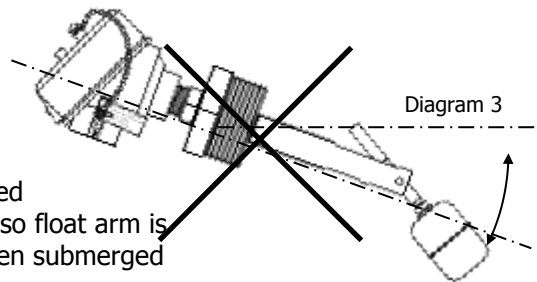

To enable the SPST version to work as a normally closed switch, the HFS Ex may be inverted during installation so float arm is horizontal without liquid (Closed circuit) and raised when submerged in liquid (open circuit).

To ensure reliable operation the HFS Ex must be installed so the float is raised vertically by the liquid.

To ensure the HFS Ex is installed so the float will rise vertically and give the correct

'normally open' or 'normally closed' operation, we advise the installer to mark the HFS Ex with a marker pen to indicate the rotational position required during instalment.

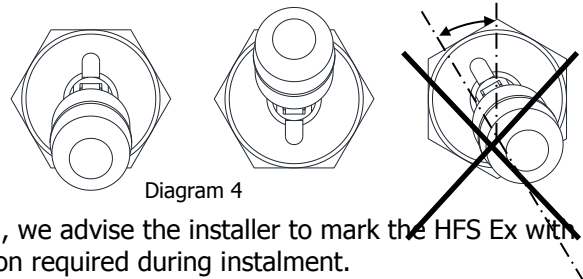

5) The magnetic float arm and sensor fork must be installed away from any magnetic field or ferrous materials which could influence its operation.

6) All versions of HFS Ex must be mounted where the ambient temperature will allow the sensor head to cool to below 80°C . This is especially significant where the process temperature is above 85°C .

7) The HFS Ex head has been fitted to the $\frac{1}{2}$ "NPT adaptor using PTFE tape and tightened ready for use. Most installations do not require the HFS Ex head to be removed but this may be necessary for reverse mounted hex plugs or where flange mount bolt are obstructed.

8) If the head needs to be removed, loosen the lid locking screw and unscrew the top of the head. Detach the wires going into the sensor fork by pressing the connector latch and pulling the connector off the circuit board. Unscrew the head from the 1/2"NPT male thread and gently pull the detached connector from the head. Do not adversely strain the wires held by the epoxy resin as this may dislodge the position of the reed switch and cause intermittent switch failure.

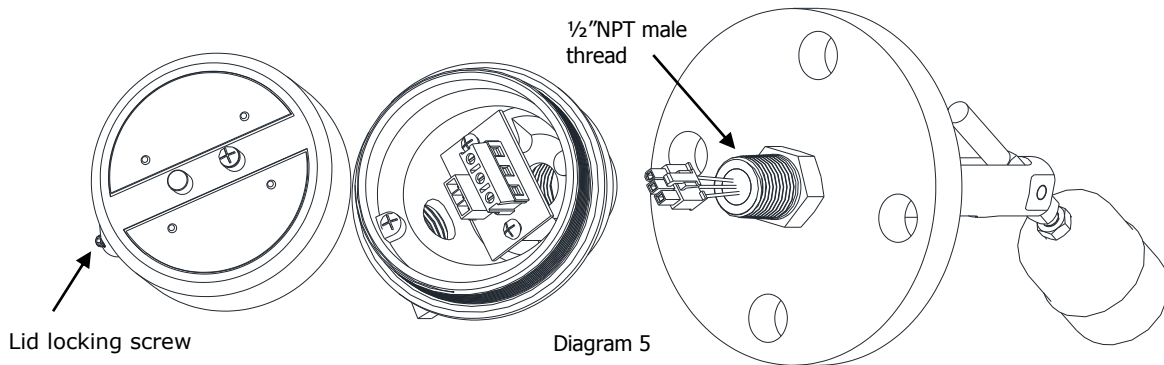

Remove old PTFE tape and apply several layers of new PTFE tape to the male thread.

As an alternative, a non setting grease according to EN 60079-1 clause 5.1 may be used to replace the PTFE tape. Failure to apply PTFE tape or grease may lead to thread galling and irreparable damage to this thread.

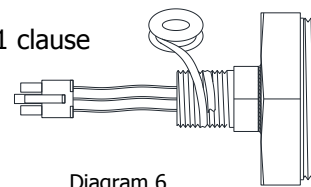



9) To refit the head, clamp the head and use a 24mm spanner on the hexagon adjacent to the male thread to tighten the joint. The head joint must be wrench tight and have a minimum of 5 revolutions of thread engagement according to EN 60079-1 clause 5.3 . Re-attach the wires to the PCB connector.

10) All HFS Ex are supplied with a drawing to identify the supplied mounting option. The supplied mounting will enable the installer to screw the switch into place. It is not possible to install a switch by welding as the welding process will damage the switch internal electronics. When tightening threaded pipe fittings as shown in diagram 6, do not use the head as a lever, always use a spanner on the pipe fitting.

- 11)  When this equipment is intended to be used in a liquid with a process temperature above 85°C it is an essential requirement that the sensor head temperature is measured to determine if the ambient air cooling is sufficient to keep the head below 80°C. With the sensor stem immersed in the process liquid at maximum temperature, a measurement of the temperature at the base of the head must be taken. Consideration of the ambient temperature during the measurement should be made and an evaluation of the maximum temperature the sensor head may reach should be recorded. Where the head temperature is expected to rise above 80°C then additional air cooling is required to keep the head below 80°C. When the sensor is intended for use in a dust environment the above test should be carried out with a layer of dust covering the sensor head.

- 12)  With the HFS Ex mounted in the tank the cables can be connected. The sensor head is not normally supplied with a cable gland so the installer is free to select a suitable explosion proof gland or conduit to mate with the M20X1.5 or 1/2"-14NPT port in the stainless steel head. When selecting components to attach to the HFS Ex the following conditions should be considered.

- 13)  If ambient temperature around the sensor head is greater than 65°C the connecting cable and its gland or stopping box must be able to withstand the increased temperature range. These components must have a minimum temperature specification of 5°C above the maximum possible ambient temperature and have a minimum ingress protection rating of IP68. When using conduit a stopping box must be fitted no more than 50mm from the sensor head. The stopping box and conduit must be installed in accordance with clause 13.2.2 IEC/EN60079-1.

- 14)  A cable strain relief can be made by passing the cable through the nylon washer and fixing a cable tie tight to the cable, leaving a minimum of 70mm after the cable tie.

- 15)  The connecting wires to the printed circuit board must be between 16 to 22AWG (Metric capacity 1.5mm²) with 6mm stripped ends. The earth wire should be connected to the screw point in the head using the crimp terminal provided.

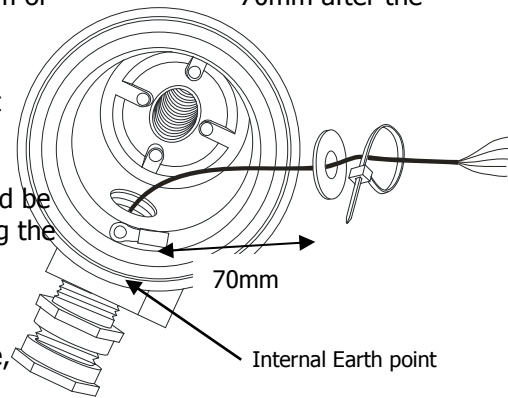
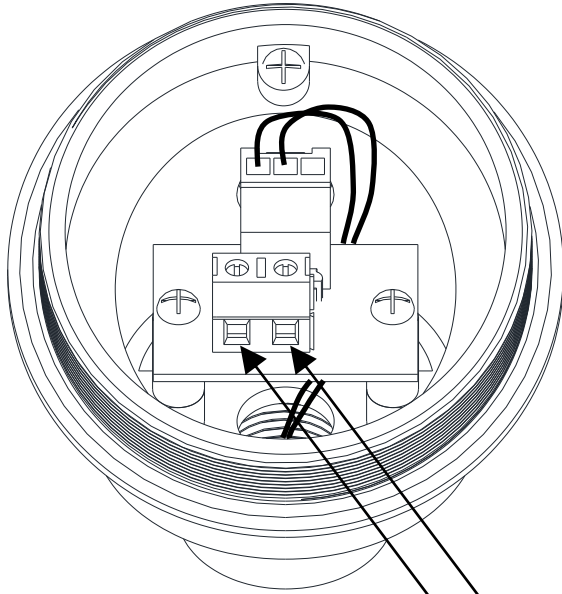

Diagram 7

Ex d flameproof cable gland for enclosures with internal volume ≥ 0.5 litres and suitable for gas, zone, temperature and cable type being used. IP6x glands must be used in dust environments.

16) The terminal board of the switch with a Form A reed (SPST) will have two screw terminals. Either terminal can be used for the 'Live' or 'Switch live' connection. The terminal board for the Form C reed (SPDT) will have three screw terminals. The centre terminal marked 'B' will be the Common.



Form A (SPST) switch
Terminal A: Live or Switched Live
Terminal B: Live or switched Live
Terminal C: Not fitted

Diagram 8

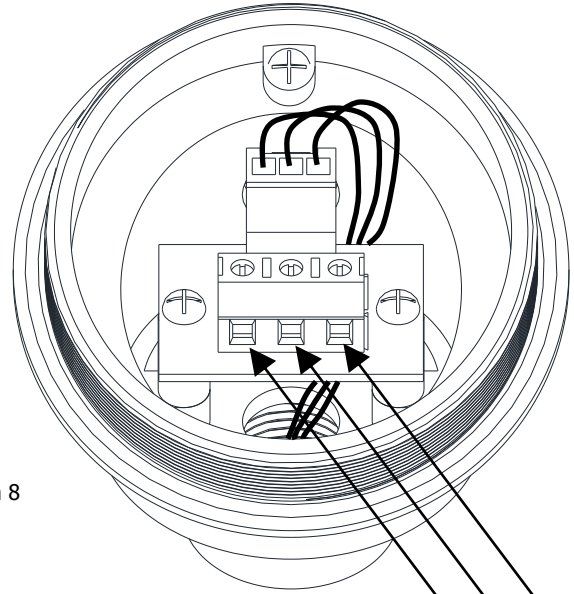

Form C (SPDT) switch
Terminal A: Normally Open contact
Terminal B: Common
Terminal C: Normally Closed contact



17) The electrical supply to all the switches must be connected through a protection device to limit excess current should a fault occur. A fast blow 1A fuse can be used to limit the current drawn. The fuse must be placed in a position where it protects the cable and the sensor should a fault occur.

18) After connecting the earth, supply and output wires screw the lid down hand-tight, keep applying torque by hand until the lid cannot be turned any further. Tighten the lid-locking screw so the lid cannot be accidentally removed.

Maintenance/Repair

Any repairs or replacements parts must be carried out by the manufacturers or their appointed repair agent.

Inspect the welded joints for fracture and fatigue.

Remove any debris which may have been attracted to the magnetic pivot arm.

Switches subject to vibration should be checked to ensure the float is securely mounted to the pivot arm.

A sensor stem immersed in hot or aggressive chemicals should be checked for corrosion on a regular basis.

Where additional air cooling was required in the installation process, the effectiveness of the cooling should be checked as described in section 12.

There are no fuses contained inside the sensor. See section 17 regarding fuse location.

The three flameproof threads as show in diagram 10, and their interconnecting parts must be clean and free from dust or debris before assembly.

Damage to flameproof threads must not be repaired, contact Deeter Electronics for replacements.

The O-ring under the head cover should be inspected for damage.

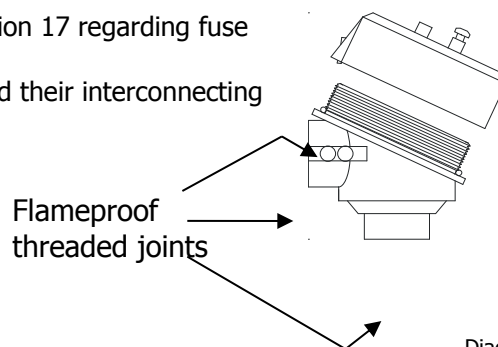

Diagram 9

Storage

Store in dry conditions without strong magnetic influence. Protect the float from impact.

Transport

Transport in a rigid container. Protect float from impact by supporting switch stem in the middle of the packing. The packing material should also prevent the switch from moving inside the container to avoid secondary impact to the float. The float and pivot arm must not be used to support the weight of the switch.

1 EU - Type Examination Certificate

2 Equipment intended for use in Potentially Explosive Atmospheres Directive 2014/34/EU

3 Certificate Number: ExVeritas 17 ATEX 0280X Issue: 0

4 Equipment: HFS Ex Horizontal Level Switch

5 Manufacturer: Deeter Electronics Ltd.

6 Address: Deeter House, Valley Road, Hughenden Valley,
High Wycombe, Bucks, HP14 4LW. UK.

7 This equipment and any acceptable variation thereto are specified in the schedule to this certificate and the documents therein referred to.

8 ExVeritas, Notified Body number 2585 in accordance with Article 9 of the Council Directive 2014/34/EU of 26 February 2014, certifies that this equipment or protective system has been found to comply with the Essential Health and Safety Requirements relating to design and construction of equipment and protective systems for use in potentially explosive atmospheres given in Annex II to the Directive

9 Compliance with the applicable Essential Health and Safety Requirements has been assured by compliance with the following Standards and section 16 of this certificate:

EN 60079-0: 2012+A11:2013 EN 60079-1:2014 EN 60079-26:2015
EN60079-31:2014

10 If the sign "X" is placed after the certificate number, it indicates that the equipment is subject to special conditions for safe use specified in the schedule to this certificate.

11 This EU-Type Examination Certificate relates only to the design, construction, examination and tests of the specified equipment or protective system in accordance to the Directive 2014/34/EU. Further requirements of the Directive apply to the manufacturing process and supply of this equipment or protective system. These are not covered by this certificate.

12 The marking of the equipment shall include the following:

 II 1/2 G Ex db IIC T* Ga/Gb
II 2 D Ex tb IIIC T*°C Db



No. 8613

On behalf of ExVeritas

S Clarke CEng MSc MIET
Certification Manager

This certificate may only be reproduced in its entirety and without any change, schedule included.

The certificate is only valid when it carries an original signature.

For help or assistance relating to this certificate, contact info@exveritas.com.

ExVeritas, Units 16-18, Abenbury Way, Wrexham Industrial Estate, Wrexham, United Kingdom LL13 9UZ.

ExVeritas® is a registered trademark, unauthorised use will lead to prosecution.

Schedule

13 Description of Equipment or Protective System

The Deeter HFS Ex is a liquid level switch with volt free terminals for use in a potentially explosive atmosphere. The liquid level is detected when the float arm is raised and aligns a magnet with a SPST or SPDT reed switch sealed inside a stainless steel housing.

The switch can be mounted horizontally in the side of a vessel via a flange or threaded plug and has the option to fit floats of different materials, sizes and specific gravity. The length between the mounting face and float can be varied dependent upon the application. An optional extension bar may be added between the mounting and the terminal head.

The following temperature classes are applicable based on the process temperature which the equipment is connected to:

Process Temperature	Temperature class for gas	Temperature class for dust
≤85°C	T5	T100°C
≤125°C	T4	T135°C
≤190°C	T3	T200°C

Rating:

0 to 240Vac. 1A 50W Max

0 to 50Vdc. 0.25A 20W Max

14 Descriptive Documents

14.1 Associated Report and Certificate History:

Report Number	Cert Issue Date	Issue	Comment
R1154/A/1	07/09/17	0	Initial issue of the Prime Certificate

14.2 Compliance Drawings:

Issue 0

Number	Date	Issue	Description
D600798	2017/02/21	Rev 1	HFS-Ex all versions – Sheet 1 of 3
D600798	2017/02/21	Rev 1	HFS-Ex all versions – Sheet 2 of 3
D600798	2017/02/21	Rev 1	HFS-Ex all versions – Sheet 3 of 3
Dwg 950553	2017/08/11	Rev 2	Adaptor ½"NPT long thread to 12mm – Sheet 1 of 2
HFS Ex Manual	2017/07/10	-	HFS Ex Manual – Sheets 1 to 10

Certificate: ExVeritas 17 ATEX 0280X Issue 0

This certificate may only be reproduced in its entirety and without any change, schedule included.

For help or assistance relating to this certificate, contact info@exveritas.com.

ExVeritas, Units 16-18, Abenbury Way, Wrexham Industrial Estate, Wrexham, United Kingdom LL13 9UZ.

ExVeritas® is a registered trademark, unauthorised use will lead to prosecution.

Schedule

15 Conditions of Certification

15.1 Special Conditions for Safe Use

- When intended to be operating with process temperatures above 85°C, the sensor head shall be sufficiently cooled to keep it below 80°C. See installation manual for details.

15.2 Conditions for Use

- Routine tests on production in accordance with clause 16 of EN/IEC 60079-1 to a pressure of at least 64.8 Bar.
- The equipment covered under this certificate incorporates previously certified components, it is therefore the responsibility of the manufacturer to monitor the status of the certification of these components and inform ExVeritas of any changes that may affect the explosion safety design of their products.

16 Essential Health and Safety Requirements

Essential Health and Safety Requirements are addressed by the standards listed in section 9 and where required the report listed in section 14.1

The manufacturer shall inform the Notified Body of any modifications to the design of the product described by this schedule.

Certificate: ExVeritas 17 ATEX 0280X Issue 0

This certificate may only be reproduced in its entirety and without any change, schedule included.

For help or assistance relating to this certificate, contact info@exveritas.com.

ExVeritas, Units 16-18, Abenbury Way, Wrexham Industrial Estate, Wrexham, United Kingdom LL13 9UZ.

ExVeritas® is a registered trademark, unauthorised use will lead to prosecution.



IECEX Certificate of Conformity

INTERNATIONAL ELECTROTECHNICAL COMMISSION IEC Certification Scheme for Explosive Atmospheres

for rules and details of the IECEx Scheme visit www.iecex.com

Certificate No.: IECEX EXV 17.0016X Issue No: 0 Certificate history:
Issue No. 0 (2017-09-07)

Status: Current Page 1 of 4

Date of Issue: 2017-09-07

Applicant: **Deeter Electronics Ltd**
Deeter House, Valley Road, Hughenden Valley, High Wycombe, Bucks, HP14 4LW
United Kingdom

Equipment: **HFS Ex Horizontal Level Switch**
Optional accessory:

Type of Protection: **Equipment protection by flameproof enclosure "d", Equipment with EPL Ga and Equipment dust ignition protection by enclosure "t"**

Marking: Ex db IIC T* Ga/Gb
Ex tb IIIC T*°C Db

Approved for issue on behalf of the IECEx
Certification Body:

Sean Clarke CEng MSc MIET

Position:

Certification Manager

Signature:
(for printed version)

Date:

1. This certificate and schedule may only be reproduced in full.
2. This certificate is not transferable and remains the property of the issuing body.
3. The Status and authenticity of this certificate may be verified by visiting the [Official IECEx Website](http://www.iecex.com).

Certificate issued by:

ExVeritas Limited
Units 16-18 Abenbury Way
Wrexham Ind. Est.
Wrexham LL 139UZ
United Kingdom





IECEX Certificate of Conformity

Certificate No: IECEX EXV 17.0016X

Issue No: 0

Date of Issue: 2017-09-07

Page 2 of 4

Manufacturer: Deeter Electronics Ltd

Deeter House, Valley Road, Hughenden Valley, High Wycombe, Bucks, HP14 4LW
United Kingdom

Additional Manufacturing location(s):

This certificate is issued as verification that a sample(s), representative of production, was assessed and tested and found to comply with the IEC Standard list below and that the manufacturer's quality system, relating to the Ex products covered by this certificate, was assessed and found to comply with the IECEx Quality system requirements. This certificate is granted subject to the conditions as set out in IECEx Scheme Rules, IECEx 02 and Operational Documents as amended.

STANDARDS:

The electrical apparatus and any acceptable variations to it specified in the schedule of this certificate and the identified documents, was found to comply with the following standards:

IEC 60079-0 : 2011 Edition:6.0	Explosive atmospheres - Part 0: General requirements
IEC 60079-1 : 2014-06 Edition:7.0	Explosive atmospheres - Part 1: Equipment protection by flameproof enclosures "d"
IEC 60079-26 : 2014-10 Edition:3.0	Explosive atmospheres – Part 26: Equipment with Equipment Protection Level (EPL) Ga
IEC 60079-31 : 2013 Edition:2	Explosive atmospheres - Part 31: Equipment dust ignition protection by enclosure "t"

*This Certificate **does not** indicate compliance with electrical safety and performance requirements other than those expressly included in the Standards listed above.*

TEST & ASSESSMENT REPORTS:

A sample(s) of the equipment listed has successfully met the examination and test requirements as recorded in

Test Report:

[GB/EXV/ExTR17.0014/00](#)

Quality Assessment Report:

[GB/SIR/QAR12.0004/05](#)



IECEX Certificate of Conformity

Certificate No: IECEX EXV 17.0016X

Issue No: 0

Date of Issue: 2017-09-07

Page 3 of 4

Schedule

EQUIPMENT:

Equipment and systems covered by this certificate are as follows:

The Deeter HFS Ex is a liquid level switch with volt free terminals for use in a potentially explosive atmosphere. The liquid level is detected when the float arm is raised and aligns a magnet with a SPST or SPDT reed switch sealed inside a stainless steel housing.

The switch can be mounted horizontally in the side of a vessel via a flange or threaded plug and has the option to fit floats of different materials, sizes and specific gravity. The length between the mounting face and float can be varied dependent upon the application. An optional extension bar may be added between the mounting and the terminal head.

The following temperature classes are applicable based on the process temperature which the equipment is connected to:

Process Temperature	Temperature class for gas	Temperature class for dust
≤85°C	T5	T100°C
≤125°C	T4	T135°C
≤190°C	T3	T200°C

Rating:

0 to 240Vac. 1A 50W Max

0 to 50Vdc. 0.25A 20W Max

SPECIFIC CONDITIONS OF USE: YES as shown below:

- When intended to be operating with process temperatures above 85°C, the sensor head shall be sufficiently cooled to keep it below 80°C. See installation manual for details.



IECEX Certificate of Conformity

Certificate No: IECEX EXV 17.0016X

Issue No: 0

Date of Issue: 2017-09-07

Page 4 of 4

Additional information:

Routine tests:

1. Routine tests on production in accordance with clause 16 of IEC 60079-1 to a pressure of at least 64.8 Bar.
2. The equipment covered under this certificate incorporates previously certified components, it is therefore the responsibility of the manufacturer to monitor the status of the certification of these components and inform ExVeritas of any changes that may affect the explosion safety design of their products.

Technical Documents:

Title:	Drawing No.:	Rev. Level:	Date:
HFS-Ex all versions – Sheet 1 of 3	D600798	Rev 1	2017/02/21
HFS-Ex all versions – Sheet 2 of 3	D600798	Rev 1	2017/02/21
HFS-Ex all versions – Sheet 3 of 3	D600798	Rev 1	2017/02/21
Adaptor ½"NPT long thread to 12mm – Sheet 1 of 2	Dwg 950553	Rev 2	2017/08/11
HFS Ex Manual – Sheets 1 to 10	HFS Ex Manual	-	2017/7/10