

20 Series Vertical Liquid Level Sensor

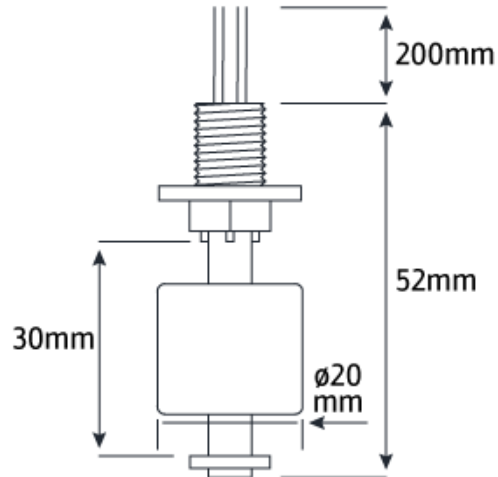

- Designed for cost sensitive high volume OEM applications.
- High reliability reed switch lifetime of 5×10^7 operations.
- Available in PVC, Polypropylene, Nylon and Acetal materials.
- Change switch operation from normally open (N/O) to normally close (N/C) by inverting float on stem.
- Ideal for beverage, automotive and consumer applications.
- A 1 meter cable is provided as standard, for custom cable lengths, contact sales office.

Technical Data

Mechanical	Electrical
M10 or 1/8" NPT Thread <ul style="list-style-type: none"> • 1 Metre Cable length (custom lengths available) • Maximum pressure 4 Bar • M10 sensors supplied with nut and nitrile washer 	Form A (SPST) switch. <ul style="list-style-type: none"> • 24V DC maximum switching voltage • 0.1A maximum switching current • 1 Watt maximum power • 150V DC breakdown voltage min. • 7/0.2mm PVC insulated cable • 7/0.2mm PTFE insulated cable with Acetal switch

Caution: NPT threads are specified in their reference size.
This size does not refer to the physical thread diameter

	PVC	Polypropylene	Nylon	Acetal
Suitable specific gravity	0.63	0.49	0.5	0.62
Operating Temperature	-20°C to + 60°C	-20°C to + 80°C	-20°C to +80°C	-20°C to + 90°C

*For Chemical resistance data contact the sales office. Higher switch ratings are available.

20 Series Vertical Liquid Level Sensor

Ordering Code

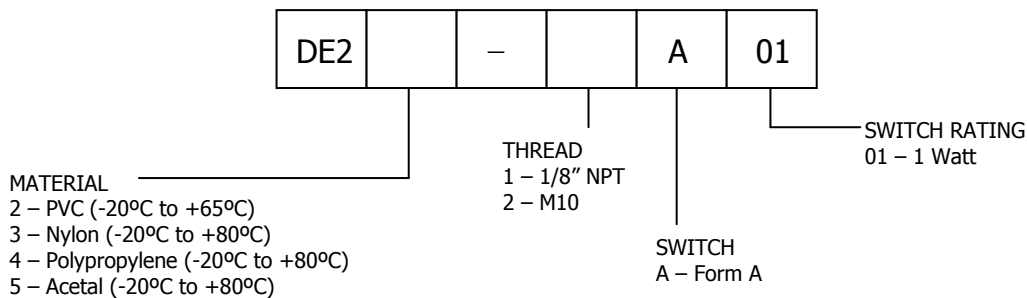

Example: DE22-2A01 = 20 Series, Material PVC, M10 mounting thread, Form A (SPST), 1 Watt float switch.
For longer cable lengths, contact the sales office.

Caution: NPT threads are specified in their reference size.
This size does not refer to the physical thread diameter.

All electrical equipment should be installed by a qualified/certified electrician.

The Deeter Group follows a policy of continual development of its products and reserves the right to change specifications and/or features without notice.